

CRLC SERIES COMMERCIAL INDOOR LIGHTING

WESTGATE
THE FUTURE IS HERE...AND IT'S QUITE BRIGHT!

CRLC4-40W-MCTP-S-D
CRLC4-40W-MCTP-S-D-WH
4" LED COMMERCIAL SQUARE & OPEN RECESSED LIGHT

Customer Name: _____

Project Name: _____

Note: _____ Type: _____



Selection:

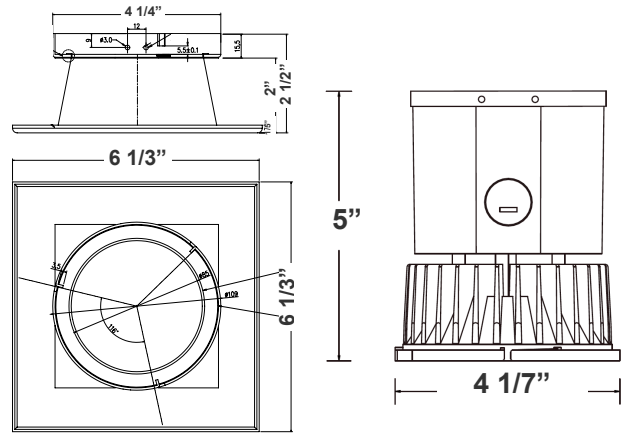

7 1/2"(H) X 6 1/3" (W)

Ideal for hotel, offices, retail outlets, restaurant, parking garages, conference room, education facilities and more.

Features

- 4" Haze & White Finish TRIM
- MCTP: The Switch Is On The Light Engine
- Mounting Options: Recessed
- 5-Year Warranty
- Lifespan: 50,000 hrs.

Technical Specifications

Electrical:

- Voltage: 120-277V AC
50/60Hz
- Wattage: 27W/34W/40W
- Power Factor: >0.90
- Efficacy: 80 LPW

Mechanical:

- 4" Haze & White Finish TRIM
- Mounting Options: Recessed
- Temperature Rating: Designed To Operate In Temperatures 113°F
- Housing Not Required. Two Spring Clips To Hold The Fixture In Place
- No IC-Rated
- Suitable for Damp Locations
- 5-Year Warranty

Lighting:

- MCTP: The Switch Is On The Light Engine
- Dimming: 0~10V Dimmable
- Total Lumens: 3200LM Max.
- Color Temperature: 3000K/3500K/4000K
- Color Rendering index: >80
- Lifespan: 50,000 hrs.

Applications:

- Ideal for hotel, offices, retail outlets, restaurant, parking garages, conference room, education facilities and more.

Other Models:

- 40W | 3200LM | CRLC4-40W-MCTP-SA-D
- 40W | 3200LM | CRLC4-40W-MCTP-SA-D-WH



Phone: (877) 805-2252 | Fax: (877) 805-2252
www.westgatemfg.com



Photometrics: CRLC4-40W-MCTP-S-D

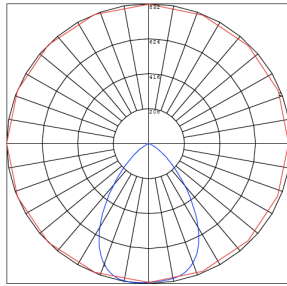
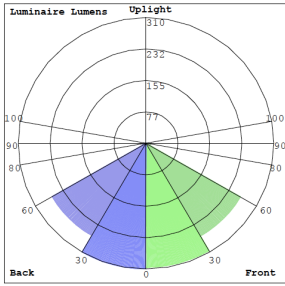

BUG Rating: B1-U1-G0

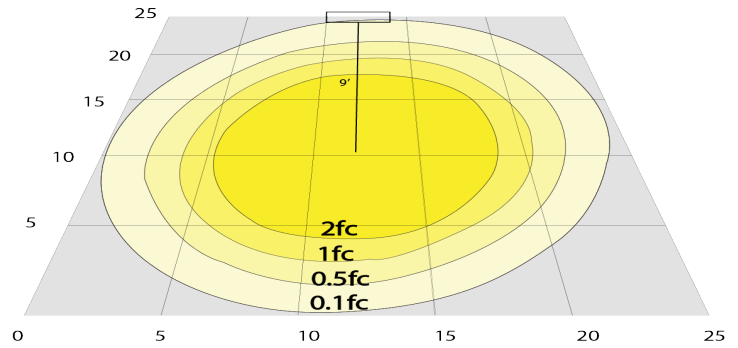

20W 5000K, Area 25" x 25' Mounting Height: 9'

Other Views:

Hazel



CRLC-EGN-40W-MCTP-D

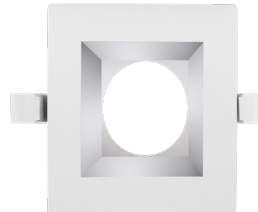

CRLC-TRM-4S



CRLC4-40W-MCTP-S-D

White



CRLC-EGN-40W-MCTP-D

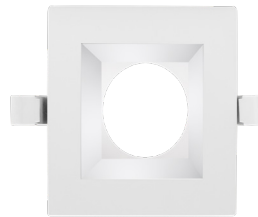

CRLC-TRM-4S-WH



CRLC4-40W-MCTP-SA-D-WH

Performance Table: CRLC4-40W-MCTP-S-D

MODEL NO.	Wattage	Voltage	Lumens	Color Temp.	BUG Rating	LPW
CRLC4-40W-MCTP-S-D	27W	120-277V	2160LM	3000K	B1-U1-G0	80
	34W		2720LM	3500K		
CRLC4-40W-MCTP-S-D-WH	40W		3200LM	4000K		

Sample Ordering

Model **Watt** **Color Temp.** **Shape** **Dimming** **Housing**

CRLC4 - 40W - MCTP - S - D -

Blank
WH = WHITE

Accessory:

Blank = No Option For Accessories
SSL4-RI = 4" SQUARE ROUGH-IN PLATE, 26" LONG

Factory-Installed Option:

Blank = No Option For Accessories
OPT-EM-HB1EXT = EXTERNAL EMERGENCY BACK UP BATTERY

Accessory:

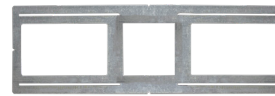

SSL4-RI
4" SQUARE ROUGH-IN
PLATE, 26" LONG

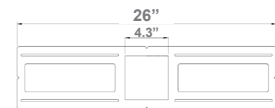

SSL4-RI
26"(W) x 6 1/5"(H)

Factory-Installed Option:



OPT-EM-HB1EXT
EXTERNAL EMERGENCY
BACK UP BATTERY

Example:

- CRLC4-40W-MCTP-S-D (FOR 20W CRLC4 MCT 120-277V)
- CRLC4-40W-MCTP-S-D OPT-EM-HB1EXT (FOR 20W CRLC4 MCT 120-277V) (EXTERNAL EMERGENCY BACK UP BATTERY)

